

PINTI *buffet*
MADE IN ITALY

CALEIDO

-
2023

PINTI *buffet*



CALEIDO

-

2023

PINTI BUFFET CALEIDO.....	5
SCEGLIE COMPONENTI / Choose and compose.....	6
I CALDI / Heated.....	9
I FREDDI / Refrigerating systems.....	17
INEUTRI / Neutral.....	37
LE BASI A PONTE / Display Bridge Base.....	55
IDISTRIBUTORI / Dispensers.....	61
PERSONALIZZAZIONE / Personalization.....	71
RICAMBI/ Spare Parts.....	73
GASTRONORM.....	74
NOTE INFORMATIVE / Technical Information.....	75

CALEIDO

Caleido è la nuova linea di buffet progettata e realizzata da **Pinti Inox** per la ristorazione moderna, caratterizzata da:
COMPLETEZZA DI GAMMA

La linea è composta da 10 basi perfettamente abbinabili tra loro, in grado di soddisfare tutte le esigenze, dal grande hotel al piccolo ristorante.

VERSATILITÀ

Ogni articolo è composto da una base in acciaio e da una parte strutturale con misure Gastronorm: ciò garantisce un altissimo grado di personalizzazione e la massima intercambiabilità delle strutture per i vari momenti della giornata, dalla prima colazione alla cena.

DESIGN MINIMAL

La semplicità delle forme rende la linea Caleido adatta sia a contesti classici, eleganti e formali, sia a location moderne e di tendenza.

COLORE

Quattro i colori delle basi disponibili: **Salvia, Burro, Caffè, Carbone.**

Trovate l'acciaio troppo freddo? È possibile personalizzare i propri articoli inserendo bacinelle in porcellana bianca.

ROBUSTEZZA

Le strutture sono realizzate in acciaio inox verniciato a polvere, adatte a un utilizzo intensivo, anche all'aperto.

PERSONALIZZAZIONE

State cercando qualcosa di diverso? Richiedete un preventivo per personalizzare la Vostra sala con il colore e la composizione che avete in mente (per maggiori informazioni, vedete pag. 67)

Caleido is the new buffet line designed and manufactured by **Pinti Inox** following the modern catering trends asking for colour options, mix of materials and technical performance

WIDE RANGE

This product line includes 10 bases that can be combined together to meet the needs of big hotels and small independent restaurants

VERSATILITY

Each item is composed of a stainless steel base and a functional part following gastronorm standards. This make the buffet modular and easily adaptable to the different meals of the day from breakfast to dinner since the same base can be used with several functional parts

MINIMAL DESIGN

The pure, neutral and minimal shape of the metal frames, makes Caleido buffet line suitable for all kind of location, from classic to modern

COLOUR

The metal bases are available in 4 different colours: **Sage, Cream, Coffee, Coal.**

Do you think the plain stainless steel is a bit too cold? Just add some porcelain trays on your gastronorm basin.

STRENGTH

All the structures are made of powder coated stainless steel, resistant to an intensive but also to an outdoor use.

PERSONALIZATION















Are you looking for something different? Ask for a quote to personalize your room with the color and the composition you are thinking about (for additional information, have a look to page 67).

SCEGLI E COMPONI

Choose and compose

Cosa state cercando? Scegliete le parti funzionali nelle varie sezioni del catalogo (Caldi, Freddi, Neutri, Basi a Ponte e Distributori), quindi abbinatetele alle basi del colore che preferite.



What are you looking for? You can choose the functional components in the specific sections of our catalogue (Hot, Cold, Neutral, Display Bridge Base and Distributors) and then combine them to your favorite bases.

PARTI FUNZ. Functional parts BASI Stands	 F180555	 F180556	 F1800950	 F1802900	 F1803100	 F1803300	 F1802830	 F1802820	 F1802840
 518_0001			✓	✓	✓	✓	✓	✓	
 518_0002									✓
 518_0003	✓	✓							
 518_0004			✓		✓				
 518_0006									
 518_0007									

✓ I CALDI / Heated

✓ I FREDDI / Refrigerating systems

✓ I NEUTRI / Neutral

 F1802600	 F1806900	 F1807000	 F1806800	 F1800940	 F1800920	 F1803200	 F1805413	 F1805420	 F1809527
	✓	✓	✓	✓	✓	✓			
✓									
		✓			✓	✓			
							✓	✓	
									✓



PINTI *buffet*

CALEIDO

-

I CALDI

Heated

Les Articles Chauffés

Warmhaltesysteme

Sistemas Calientes



BREVILLE
MADE IN ITALY

LA PARTE FUNZIONALE



Cod. F1805555
CHAFING DISH
Chafing dish 1/1 - Chafing Dish
Chafing Dish - Cubet.

COMPOSIZIONE:

Cod. D05B5559
1 VASCA BAGNOMARIA 1/1 h 110
Gastronorm bain marie basin - Bac de bain-marie GN - Wasserbad-Wanne GN - Recipiente baño-maria GN

Cod. D05B5558
1 COPERCHIO GN C/ POMOLO
GN lid with knob - Couvercle GN avec pommeau et - Gastronorm deckel mit Knopf - Tapa gastronómica GN con pomo

Cod. 5BA11065
1 BACINELLA GN 1/1 h 65
Gastronorm basin - Bac gastronorm - Durchbrochener basis - Cubeta gastronómica

Cod. 97200078
2 FORNELLETTI INOX
Stainless steel burner holder - Fourneau - Kocher - Quemadores

OPTIONAL:

IL CHAFING DISH È PREDISPOSTO PER L'INSERIMENTO DELLA RESISTENZA ELETTRICA CON REGOLATORE
Cod. 97150118
230 Volt 700 Watt
The chafing dish can use a heater.

LE BASI



Cod. 518A0003
BASE ALTA SALVIA h cm 20
High stand sage - Base haute vert - Hoher Sockel Salvia - Base alta verte



Cod. 518B0003
BASE ALTA BURRO h cm 20
High stand cream - Base haute crème - Hoher Sockel Burro - Base altar crema



Cod. 518C0003
BASE ALTA CAFFÈ h cm 20
High stand coffe - Base haute brun - Hoher Sockel Caffè - Base alta marron



Cod. 518D0003
BASE ALTA CARBONE h cm 20
High stand coal - Base haute gris - Hoher Sockel Carbone - Base alta gris



lid close
cm 29,2
-
lid open
cm 56,5

cm 36,7

cm 57

CHAFING DISH RETTANGOLARE GN 1/1 CON CHIUSURA A FRIZIONE

GN complete rectangular chafing dish 1/1 friction closing.

Chafing Dish rectangulaire GN 1/1 avec fermeture à friction.

Chafing Dish rechteckig GN 1/1 komplett mit Kupplungsschliessung.

Cubeta GN 1/1 con cierre con fricción.



PINTELLI
MADE IN ITALY

OPTIONAL

1/1

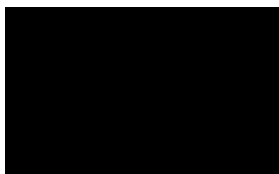

Cod. 97150785
BACINELLA PORCELLANA 1/1 h cm 65
China basin 1/1 - Bac en porcelaine -
Porzellanschüssel - Cuenca de procelana



Cod. 97150786
BACINELLA PORCELLANA 2/3 h cm 65
China basin 2/3 - Bac en porcelaine -
Porzellanschüssel - Cuenca de procelana

2/3



Cod. 97150787
BACINELLA PORCELLANA 1/2 h cm 65
China basin 1/2 - Bac en porcelaine -
Porzellanschüssel - Cuenca de procelana



Cod. 97150788
BACINELLA PORCELLANA 1/3 h cm 65
China basin 1/3 - Bac en porcelaine -
Porzellanschüssel - Cuenca de procelana

1/2

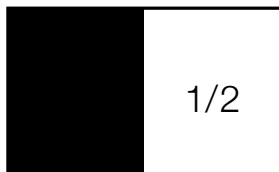

1/3

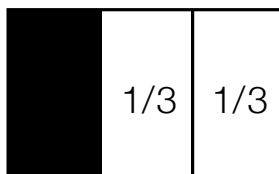



LA PARTE FUNZIONALE



Cod. F1805556
ZUPPIERA RISCALDATA 2 STAZIONI
2 Heated soup bowls - Soupière a 2 stations -
Suppenstation - Sopera 2 staciones

COMPOSIZIONE:

Cod. D0595559
1 VASCA BAGNOMARIA 1/1
h 110 C/GANCI
Gastronorm bain marie basin - Bac de
bain-marie GN - Wasserbad-Wanne GN -
Recipiente baño-maría GN

Cod. 30595557
1 COPERCHIO PORTA ZUPPIERA GN
GN lid for soup bowl - Couvercle
pour soupière GN - Deckel für
Suppenschüsselhalter GN - Tapa porta-
sopera GN

Cod. 30597222
2 ZUPPIERE It 5 - Ø cm 22
Soup bowl - Soupière - Suppenschüssel -
Sopera

Cod. 30877522
2 COPERCHI ZUPPIERA Ø cm 22
Lid - Couvercle - Deckel - Tapa

Cod. 97200078
2 FORNELLETTI INOX
Stainless steel burner holder - Fourneau -
Kocher - Quemadores

OPTIONAL:

IL CHAFING DISH È PREDISPOSTO PER
L'INSERIMENTO DELLA RESISTENZA
ELETTRICA CON REGOLATORE
Cod. 97150118
230 Volt 700 Watt
The chafing dish can use a heater.

LE BASI



Cod. 518A0003
BASE ALTA SALVIA h cm 20
High stand sage - Base haute vert - Hoher
Sockel Salvia - Base alta verte



Cod. 518B0003
BASE ALTA BURRO h cm 20
High stand cream - Base haute crème -
Hoher Sockel Burro - Base altar crema



Cod. 518C0003
BASE ALTA CAFFÈ h cm 20
High stand coffe - Base haute brun - Hoher
Sockel Caffè - Base alta marron



Cod. 518D0003
BASE ALTA CARBONE h cm 20
High stand coal - Base haute gris - Hoher
Sockel Carbone - Base alta gris



ZUPPIERA 2 STAZIONI RISCALDATA It 10

2 Heated soup bowls.

Soupière a 2 stations.

Suppenstation.

Sopera 2 staciones.



PINTI *buffet*

CALEIDO

-

I FREDDI

Refrigerating Systems

Les Articles Réfrigérés

Kühlsysteme

Sistemas Refrigerados



LA PARTE FUNZIONALE



Cod. F1800950
VASSOIO PER AFFETTATI REFRIGERATO
Rectangular refrigerated tray with cover for sliced salami - Plateau rectangulaire réfrigérant avec cloche pour charcuterie. - Rechteckiges Tablett für gekühlten Aufschnitt mit Haube - Bandeja rectangular para fiambre en lonchas refrigerado con campana

COMPOSIZIONE:

Cod. 5BA11020
1 BACINELLA GN 1/1 h 20
Gastronorm basin
Bac gastronorm
Durchbrochener basis
Cubeta gastronormic

Cod. 5TI11040
1 TEGLIA GN 1/1 h 40
Gastronorm basin
Plat gastronorm
Durchbrochener blech
Fuente gastronormic

Cod. 5FP11000
1 FALSO FONDO FORATO PC 1/1
Perforated PC false bottom
Faux fond percé PC
Gelochter falscher Boden PC
Doble fondo perforado PC

Cod. 97150276
4 GEL PACK cm 20x9,8
Refrigerating brick
Briquette réfrigérante
Kühlakku
Refrigerad

Cod. 97150856
1 CUPOLA RETT. APRIBILE PC
Rectangular dome lid
Cloche rectangulaire
Rolltop
Campana rectangular

LE BASI



Cod. 518A0001
BASE BASSA SALVIA h cm 7,5
Low base sage - Base basse vert
Niedrigen Basis Salvia - Base baja verde



Cod. 518B0001
BASE BASSA BURRO h cm 7,5
Low base cream - Base basse crème
Niedrigen Basis Burro - Base baja crema



Cod. 518C0001
BASE BASSA CAFFÈ h cm 7,5
Low base coffee - Base basse brun
Niedrigen Basis Caffè - Base baja marron



Cod. 518D0001
BASE BASSA CARBONE h cm 7,5
Low base coal - Base basse gris
Niedrigen Basis Carbone - Base baja gris



VASSOIO PER AFFETTATI REFRIGERATO

Rectangular refrigerated tray with cover for sliced salami.

Plateau rectangulaire réfrigérant avec cloche pour charcuterie.

Rechteckiges Tablett für gekühlten Aufschnitt mit Haube.

Bandeja rectangular para fiambre en lonchas refrigerado con campana.



Pantruffa

Pantruffa
MADE IN ITALY

LA PARTE FUNZIONALE



Cod. F1802900
PORTA YOGURT FORATO (Ø cm 5,5) REFRIG.
Refrigerated tray with 22 holes for yoghurt
- Porte-yaourt réfrigérant à 22 trous
- Joghurthalterschale, gekühlt mit 22
Plätzen - Porta-yogur refrigerado con 22
compartimentos

COMPOSIZIONE:

Cod. 5BP11065
1 BACINELLA GN PC 1/1 h 65
PC Gastronorm basin
Bac gastronorm PC
Durchbrochener basis PC
Cubeta gastronómico PC

Cod. 5BFY1120
1 BACINELLA FORATA
PER PORTA YOGURT
Perforated tray for yoghurt
Plateau percé porte-yaourt
Gelochte Joghurthalterschale
Cuenco perforado para porta-yogurt

Cod. 5FP11000
1 FALSO FONDO FORATO PC
Perforated PC false bottom
Faux fond percé PC
Gelochter falscher Boden PC
Doble fondo perforado PC

Cod. 97150276
4 GEL PACK cm 20x9,8
Refrigerating brick
Briquette réfrigérante
Kühlakku
Refrigerad

LE BASI



Cod. 518A0001
BASE BASSA SALVIA h cm 7,5
Low base sage - Base basse vert
Niedrigen Basis Salvia - Base baja verde



Cod. 518B0001
BASE BASSA BURRO h cm 7,5
Low base cream - Base basse crème
Niedrigen Basis Burro - Base baja crema



Cod. 518C0001
BASE BASSA CAFFÈ h cm 7,5
Low base coffee - Base basse brun
Niedrigen Basis Caffè - Base baja marron



Cod. 518D0001
BASE BASSA CARBONE h cm 7,5
Low base coal - Base basse gris
Niedrigen Basis Carbone - Base baja gris

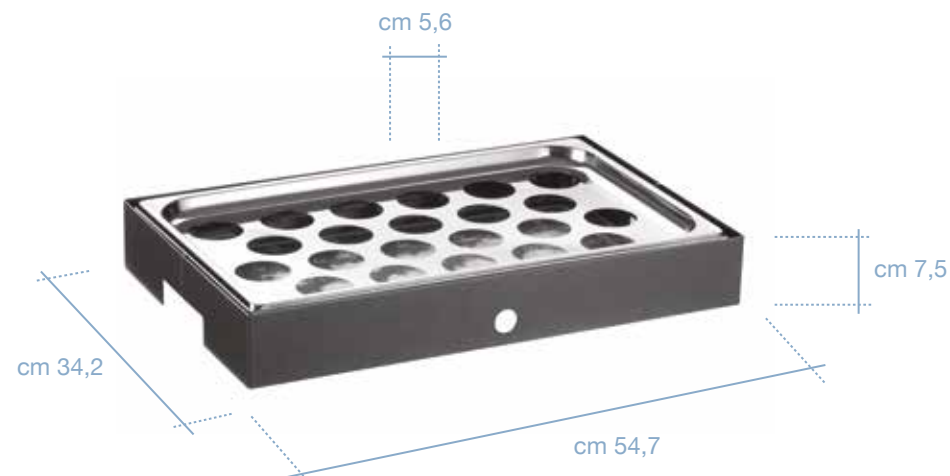

VASSOIO PORTA YOGURT REFRIGERATO (22 FORI Ø cm 5,5)

Refrigerated tray with 22 holes for yoghurt.

Porte-yoghurt réfrigérant à 22 trous.

Joghurthalterschale, gekühlt mit 22 Plätzen.

Porta-yoghurt refrigerado con 22 compartimentos.



LA PARTE FUNZIONALE



Cod. F1803100
PORTA BURRO E MARMELLATA REFRIG.
Perforated and refrigerated tray with cover for jam and butter - Plateau percé réfrigérant avec cloche pour beurre et confiture - Gelochtes Butter- und Marmelade-Tablett, gekühlt mit Haube - Bandeja perforada para mantequilla y mermelada refrigerada con campana

COMPOSIZIONE:

Cod. 5BA11040
1 BACINELLA GN 1/1 h 40
Gastronorm basin
Bac gastronorm
Durchbrochener basis
Cubeta gastronormic

Cod. F1133100
1 VASSOIO PORTABURRO FORATO
Perforated butter tray
Plateau percé pour beurre
Butter-Tablett
Mantequillera perforado

Cod. 5FP11000
1 FALSO FONDO FORATO PC 1/1
Perforated PC false bottom
Faux fond percé PC
Gelochter falscher Boden PC
Doble fondo perforado PC

Cod. 97150276
4 GEL PACK cm 20x9,8
Refrigerating brick
Briquette réfrigérante
Kühlakku
Refrigerad

Cod. 97150856
1 CUPOLA RETT. APRIBILE PC
Rectangular dome lid
Cloche rectangulaire
Rolltop
Campana rectangular

LE BASI



Cod. 518A0001
BASE BASSA SALVIA h cm 7,5
Low base sage - Base basse vert
Niedrigen Basis Salvia - Base baja verde



Cod. 518B0001
BASE BASSA BURRO h cm 7,5
Low base cream - Base basse crème
Niedrigen Basis Burro - Base baja crema



Cod. 518C0001
BASE BASSA CAFFÈ h cm 7,5
Low base coffee - Base basse brun
Niedrigen Basis Caffè - Base baja marron



Cod. 518D0001
BASE BASSA CARBONE h cm 7,5
Low base coal - Base basse gris
Niedrigen Basis Carbone - Base baja gris

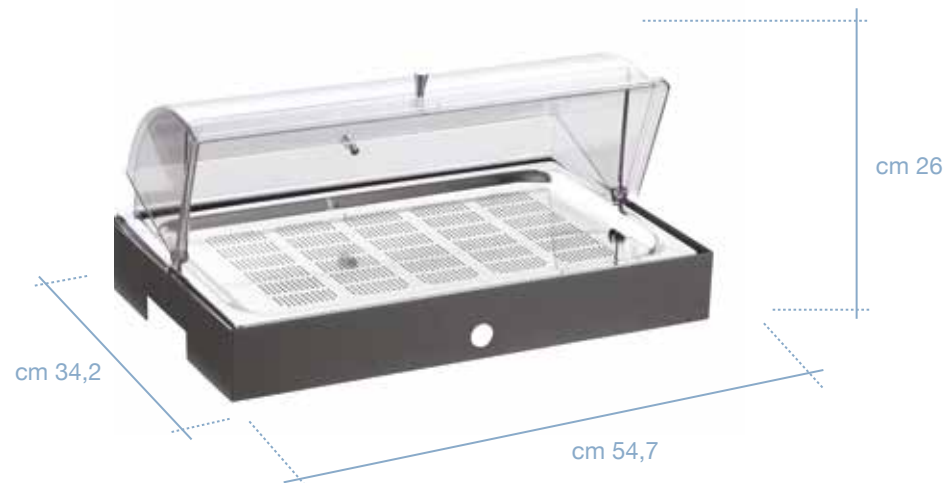

VASSOIO FORATO PORTA BURRO E MARMELLATA REFRIGERATO

Perforated and refrigerated tray with cover for jam and butter.
Plateau percé réfrigérant avec cloche pour beurre et confiture.
Gelochtes Butter- und Marmelade-Tablett, gekühlt mit Haube.
Bandeja perforada para mantequilla y mermelada refrigerada con campana.



LA PARTE FUNZIONALE



Cod. F1803300
PIASTRA ACCIAIO INOX REFRIGERATA
Refrigerated stainless steel plate - Plaque réfrigérée - Gekühlte Edelstahlplatte - Placa de acero refrigerada

COMPOSIZIONE:

Cod. 97150857
1 PIASTRA INOX GN 1/1
cm 54x33,5x0,7
Refrigerated stainless steel plate
Plaque réfrigérée
Gekühlte Edelstahlplatte
Placa de acero

Cod. 5TI11020
1 TEGLIA GN 1/1 h 20
Gastronorm basin
Plat gastronorm
Durchbrochener blech
Fuente gastronómico

Cod. 5FP11000
1 FALSO FONDO FORATO PC
Perforated PC false bottom
Faux fond percé PC
Gelochter falscher Boden PC - Doble fondo perforado PC

Cod. 97150276
4 GEL PACK cm 20x9,8
Refrigerating brick
Briquelette réfrigérante
Kühlakku
Refrigerad

Cod. 97150856
1 CUPOLA RETT. APRIBILE PC
Rectangular dome lid
Cloche rectangulaire
Rolltop
Campana rectangular

LE BASI



Cod. 518A0001
BASE BASSA SALVIA h cm 7,5
Low base sage - Base basse vert
Niedrigen Basis Salvia - Base baja verde



Cod. 518B0001
BASE BASSA BURRO h cm 7,5
Low base cream - Base basse crème
Niedrigen Basis Burro - Base baja crema



Cod. 518C0001
BASE BASSA CAFFÈ h cm 7,5
Low base coffee - Base basse brun
Niedrigen Basis Caffè - Base baja marron



Cod. 518D0001
BASE BASSA CARBONE h cm 7,5
Low base coal - Base basse gris
Niedrigen Basis Carbone - Base baja gris



PIASTRA ACCIAIO INOX REFRIGERATA

Refrigerated stainless steel plate.

Plateau rectangulaire réfrigérant avec cloche pour charcuterie.

Gekühlte Edelstahlplatte.

Placa de acero inoxidable refrigerada.



COMPOSIZIONE

1 PORTA BROCCHE h cm 7,5
Jug holder
Porte-carafes
Krughalter
Porta-jarras
Cod. 518A0005 SALVIA / sage
Cod. 518B0005 BURRO / cream
Cod. 518C0005 CAFFÈ / coffee
Cod. 518D0005 CARBONE / coal

Cod. 97150305
1 VASCHETTA RACCOGLI GOCCE
Drop-saver bowl
Bac à goutess
Tropfschale
Cubeta de recoger gotas

Cod. 97150276
2 GEL PACK cm 20x9,8
Refrigerating brick
Briquelette réfrigérante
Kühlakku
Refrigerad

Cod. 97150861
1 COPERCHIO INOX PER
VASCHETTA RACCOGLI GOCCE
cm 39x12,8x1h
Drop-saver lid for drop-saver bowl
Couvercle por bac à goutes
Edelstahlabdeckung für Tropfschale
Tapa de acero por cubeta de recoger gotas

Cod. F1800014
1 RIALZO INTERNO PER PIASTRA
INOX SMALL
Internal metal support for small
stainless steel plate
Support interne pour petit plateau
rectangulaire réfrigérant
Innere Metallhalterung für kleine
Edelstahlplatte
Suporte interno metálico para placa de
acero pequeña



Cod. 518A0305
PIASTRA ACCIAIO INOX REFRIG. SMALL SALVIA
39x12,8x7,5h cm
Small refrigerated stainless steel plate sage.
Petit Plateau rectangulaire réfrigérant vert.
Kleine Kühlplatte aus Edelstahl Salvia.
Placa de acero refrigerada pequeña verde.



Cod. 518B0305
PIASTRA ACCIAIO INOX REFRIG. SMALL BURRO
39x12,8x7,5h cm
Small refrigerated stainless steel plate cream.
Petit Plateau rectangulaire réfrigérant crème.
Kleine Kühlplatte aus Edelstahl Burro.
Placa de acero refrigerada pequeña crema.



Cod. 518C0305
PIASTRA ACCIAIO INOX REFRIG. SMALL CAFFÈ
39x12,8x7,5h cm
Small refrigerated stainless steel plate coffee.
Petit Plateau rectangulaire réfrigérant brun.
Kleine Kühlplatte aus Edelstahl Saf Caffè.
Placa de acero refrigerada pequeña marron.



Cod. 518D0305
PIASTRA ACCIAIO INOX REFRIG. SMALL CARBONE
39x12,8x7,5h cm
Small refrigerated stainless steel plate coal.
Petit Plateau rectangulaire réfrigérant gris.
Kleine Kühlplatte aus Edelstahl Carbone.
Placa de acero refrigerada pequeña gris.



LA PARTE FUNZIONALE



Cod. F1802830
 PORTA UOVA E VERDURA REFRIGERATO
 Double wall refrigerated GN tray with cover for eggs and vegetables - Double plateau GN réfrigérant à double paroi avec cloche pour œufs et légumes - Doppeltes Eier- und Gemüsetablett GN, doppelwandig, gekühlt mit Haube - Bandeja doble GN porta-huevos y verduras con doble pared refrigerada con campana

COMPOSIZIONE:

Cod. FBAT1220
 1 VASSOIO PORTA UOVO GN 1/2
 Egg tray - Oeufrier - Eier-Tablett - Bandeja porta-huevos

Cod. 5BF12040
 1 BACINELLA GN 1/2 h 40 FORATA
 Perforated basin - Bac percé - Eier-Tablett - Cuenco perforado

Cod. 5BP12065
 2 BACINELLE GN PC 1/2 h 65
 PC Gastronorm basin - Bac gastronorm PC - Durchbrochener basis PC - Cubeta gastronormic PC

Cod. 5FP12000
 2 FALSI FONDI FORATI GN PC 1/2
 Perforated false bottom - Faux fond percé PC - Gelochter falscher Boden PC - Doble fondo perforado PC

Cod. 97150276
 4 GEL PACK cm 20x9,8
 Refrigerating brick - Briquette réfrigérante - Kühlakku - Refrigerad

Cod. 97150856
 1 CUPOLA RETT. APRIBILE PC
 Rectangular dome lid - Cloche rectangulaire - Rolltop - Campana rectangular



LE BASI



Cod. 518A0001
 BASE BASSA SALVIA h cm 7,5
 Low base sage - Base basse vert
 Niedrigen Basis Salvia - Base baja verde



Cod. 518B0001
 BASE BASSA BURRO h cm 7,5
 Low base cream - Base basse crème
 Niedrigen Basis Burro - Base baja crema



Cod. 518C0001
 BASE BASSA CAFFÈ h cm 7,5
 Low base coffee - Base basse brun
 Niedrigen Basis Caffè - Base baja marron



Cod. 518D0001
 BASE BASSA CARBONE h cm 7,5
 Low base coal - Base basse gris
 Niedrigen Basis Carbone - Base baja gris



VASSOIO PORTA UOVA E VERDURA REFRIGERATO

Double wall refrigerated tray with cover for eggs and vegetables.
 Double plateau réfrigérant à double paroi avec cloche pour œufs et légumes.
 Doppeltes Eier- und Gemüsetablett, doppelwandig, gekühlt mit Haube.
 Bandeja doble porta-huevos y verduras con doble pared refrigerada con campana.



PINTELLI
MADE IN ITALY

PINTELLI
MADE IN ITALY

LA PARTE FUNZIONALE



Cod. F1802820
PORTA VERDURE 4 SCOMPARTI REFRIG.
Refrigerated basin with cover for vegetables
- Plateau légumes réfrigérant avec cloche
- Gemüseschalenhalter, gekühlt mit Haube
- Porta-verduras refrigerado con campana

COMPOSIZIONE:

Cod. 5BP11065
1 BACINELLA GN PC 1/1 h 65
Gastronorm basin
Bac gastronorm
Durchbrochener basis
Cubeta gastronormic

Cod. 5BA28040
4 BACINELLE GN 2/8 h 40
Gastronorm basin
Bac gastronorm
Durchbrochener basis
Cubeta gastronormic

Cod. 5FP11000
1 FALSO FONDO GN PC 1/1
h 15 FORATO
PC Perforated false bottom
Faux fond percé PC
Gelochter falscher Boden PC
Doble fondo perforado PC

Cod. 97150276
4 GEL PACK cm 20x9,8
Refrigerating brick
Briquelette réfrigérante
Kühlakku
Refrigerad

Cod. 97150856
1 CUPOLA RETT. APRIBILE PC
Rectangular dome lid
Cloche rectangulaire
Rolltop
Campana rectangular

LE BASI



Cod. 518A0001
BASE BASSA SALVIA h cm 7,5
Low base sage - Base basse vert
Niedrigen Basis Salvia - Base baja verte



Cod. 518B0001
BASE BASSA BURRO h cm 7,5
Low base cream - Base basse crème
Niedrigen Basis Burro - Base baja crema



Cod. 518C0001
BASE BASSA CAFFÈ h cm 7,5
Low base coffee - Base basse brun
Niedrigen Basis Caffè - Base baja marron



Cod. 518D0001
BASE BASSA CARBONE h cm 7,5
Low base coal - Base basse gris
Niedrigen Basis Carbone - Base baja gris



VASSOIO PORTA VERDURE 4 SCOMPARTI REFRIGERATO

Refrigerated basin with cover for vegetables.

Plateau légumes réfrigérant avec cloche.

Gemüseschalenhalter, gekühlt mit Haube.

Porta-verduras refrigerado con campana.



LA PARTE FUNZIONALE



Cod. F1802840
PORTA YOGURT E VERDURE REFRIG.
 Double wall refrigeret basin with cover for yoghurt and vegetables - Plateau réfrigérant double paroi avec cloche pour yaourt et légumes - Joghurt- und Gemüseschalenhalter, doppelwandig, gekühlt mit Haube - Porta-yogur y verduras con doble pared refrigerada con campana

COMPOSIZIONE:

Cod. D0595561
 1 VASCA BAGNOMARIA 1/1
 h 110 C/VITI
 Gastronorm bain marie basin
 Bac de bain-marie GN
 Wasserbad-Wanne GN
 Recipiente baño-maría GN

Cod. 5BP13100
 3 BACINELLE GN PC 1/3 h 100
 PC Gastronorm basin
 Bac gastronorm PC
 Durchbrochener basis PC
 Cubeta gastronómico PC

Cod. 5FF11000
 1 FALSO FONDO GN 1/1 FORATO
 Perforated false bottom
 Faux fond percé
 Gelochter falscher Boden
 Doble fondo perforado

Cod. 97150276
 4 GEL PACK cm 20x9,8
 Refrigerating brick
 Briquette réfrigérante
 Kühlakku
 Refrigerad

Cod. 97150856
 1 CUPOLA RETT. APRIBILE PC
 Rectangular dome lid
 Cloche rectangulaire
 Rolltop
 Campana rectangular



LE BASI



Cod. 518A0002
BASE MEDIA SALVIA h cm 12,5
 Medium base sage - Base moyenne vert
 Mittelgroße Basis Salvia - Base média verte



Cod. 518B0002
BASE MEDIA BURRO h cm 12,5
 Medium base cream - Base moyenne crème
 Mittelgroße Basis Burro - Base media crema



Cod. 518C0002
BASE MEDIA CAFFÈ h cm 12,5
 Medium base coffee - Base moyenne brun
 Mittelgroße Basis Caffè - Base media marron



Cod. 518D0002
BASE MEDIA CARBONE h cm 12,5
 Medium base coal - Base moyenne gris
 Mittelgroße Basis Carbone - Base média gris



VASSOIO PORTA YOGURT E VERDURE DOPPIA PARETE REFRIGERATO

Double wall refrigeret basin with cover for yoghurt and vegetables.
 Plateau réfrigérant double paroi avec cloche pour yaourt et légumes.
 Joghurt- und Gemüseschalenhalter, doppelwandig, gekühlt mit Haube.
 Porta-yogur y verduras con doble pared refrigerada con campana.



LA PARTE FUNZIONALE



Cod. F1802600
VASCA GHIACCIO
Ice bucket - Bac à galcon - Eisbehälter-
Recipiente hielo

COMPOSIZIONE:

Cod. 30595559
1 VASCA CHAFING DISH 1/1 h 110
Chafing dish basin
Bac de chauffe-plats
Chafing Dish basis
Recipiente calentaplatos

Cod. 5TFC1140
1 TEGLIA FORATA PER
PORTA CHAMPAGNE
Perforated tray for champagne
Plateau rectangulaire pour champagne
Gelochtes Blech für Champagner-Kübel
Fuente perforada para porta-champagne

Cod. F1132600
2 PENTOLE PORTA
CHAMPAGNE It 7
Champagne pot
Bain-marie marmite pour champagne
Champagner-Kübel
Cubo porta-champagne

LE BASI



Cod. 518A0002
BASE MEDIA SALVIA h cm 12,5
Medium base sage - Base moyenne vert
Mittelgroße Basis Salvia - Base média verte



Cod. 518B0002
BASE MEDIA BURRO h cm 12,5
Medium base cream - Base moyenne crème
Mittelgroße Basis Burro - Base média crema



Cod. 518C0002
BASE MEDIA CAFFÈ h cm 12,5
Medium base coffee - Base moyenne brun
Mittelgroße Basis Caffè - Base média marron



Cod. 518D0002
BASE MEDIA CARBONE h cm 12,5
Medium base coal - Base moyenne gris
Mittelgroße Basis Carbone - Base média gris



VASCA GHIACCIO

Bac à glaçons.

Eisbehälter.

Recipiente hielo.



PINTI *buffet*

CALEIDO

-

I NEUTRI

Neutral

Les Articles Neutres

Neutral

Neutros



Pittagallo

LA PARTE FUNZIONALE



Cod. F1806900
CESTA PANE WENGE
Wenge bread basket with cover - Corbeille à pain avec cloche - Brotkorb mit Haube - Cesto para el pan con campana



Cod. F1806700
CESTA PANE PAGLIA
Paille bread basket with cover - Corbeille à pain avec cloche - Brotkorb mit Haube - Cesto para el pan con campana

COMPOSIZIONE:

Cod. 5T111040
1 TEGLIA 1/1 h 40
Gastronorm basin
Plat gastronorm
Durchbrochener blech
Fuente gastronómico

Cod. L7150759
1 CESTA PANE WENGE C/FORCELLE
Wenge bread basket with hooks
Corbeille a pain avec crochets
Brotkorb mit Aufnahmegabeln für Haub
Cesto para el pan con asas

Cod. L7150760
1 CESTA PANE PAGLIA C/FORCELLE
Paille bread basket with hooks
Corbeille a pain avec crochets
Brotkorb mit Aufnahmegabeln für Haub
Cesto para el pan con asas

Cod. 97150856
1 CUPOLA RETT. APRIBILE PC
Rectangular dome lid- Cloche rectangulaire
Rolltop - Campana rectangular

LE BASI



Cod. 518A0001
BASE BASSA SALVIA h cm 7,5
Low base sage - Base basse vert
Niedrigen Basis Salvia - Base baja verde



Cod. 518B0001
BASE BASSA BURRO h cm 7,5
Low base cream - Base basse crème
Niedrigen Basis Burro - Base baja crema



Cod. 518C0001
BASE BASSA CAFFÈ h cm 7,5
Low base coffee - Base basse brun
Niedrigen Basis Caffè - Base baja marron



Cod. 518D0001
BASE BASSA CARBONE h cm 7,5
Low base coal - Base basse gris
Niedrigen Basis Carbone - Base baja gris



CESTA PANE

Bread basket with cover.

Corbeille à pain avec cloche.

Brotkorb mit Haube.

Cesto para el pan con campana.



A glass display case containing several jars of jam and packets of PNT coffee. The base of the case is brown with the PNT logo and the text "PNT coffee" and "MILANO 1877" visible.

A large white tray with a brown base, filled with various snacks including bread, crackers, and dips. The base of the tray has the PNT logo and the text "PNT coffee" and "MILANO 1877" visible.

A wooden tray containing dark breadsticks and flatbread.



LA PARTE FUNZIONALE



Cod. F1807000
CESTA PANE IN TESSUTO
Woven bread basket - Panièr pan en tissuts
- Brotkorb aus Stoff - Cesto para el pan de tejido

COMPOSIZIONE:

Cod. 5T111040
1 TEGLIA 1/1 h 40
Gastronorm basin
Plat gastronorm
Durchbrochener blech
Fuente gastronòmic

Cod. 97150860
1 CESTA PANE IN TESSUTO
Woven bread basket
Panièr pan en tissuts
Brotkorb aus Stoff
Cesto para el pan de tejido

Cod. 97150856
1 CUPOLA RETT. APRIBILE PC
Rectangular dome lid
Cloche rectangulaire
Rolltop
Campana rectangular

LE BASI



Cod. 518A0001
BASE BASSA SALVIA h cm 7,5
Low base sage - Base basse vert
Niedrigen Basis Salvia - Base baja verte



Cod. 518B0001
BASE BASSA BURRO h cm 7,5
Low base cream - Base basse crème
Niedrigen Basis Burro - Base baja crema



Cod. 518C0001
BASE BASSA CAFFÈ h cm 7,5
Low base coffee - Base basse brun
Niedrigen Basis Caffè - Base baja marron



Cod. 518D0001
BASE BASSA CARBONE h cm 7,5
Low base coal - Base basse gris
Niedrigen Basis Carbone - Base baja gris



CESTA PANE IN TESSUTO

Woven bread basket.

Panièr pain en tissuts.

Brotkorb aus Stoff.

Cesto para el pan de tejido.



LA PARTE FUNZIONALE



Cod. F1806800
TAGLIERE PANE IN LEGNO
Bread board - Planche à couper le pain -
Brotschneidebrett in Nussbaumfarbe - Tabla
de cortar pan

COMPOSIZIONE:

Cod. 5T111020
1 TEGLIA GN 1/1 h 20
Gastronorm basin
Plat gastronorm
Durchbrochener blech
Fuente gastronómic

Cod. 97150859
2 TAGLIERE PANE
IN NOCE CANALETTO cm 27,5x34,5
"Canaletto" walnut bread chopping board
Coupe pain enuix "Canaletto"
Brotschneidebrett in Nussbaumfarbe
Tabla de noce de cortar pan

LE BASI



Cod. 518A0001
BASE BASSA SALVIA h cm 7,5
Low base sage - Base basse vert
Niedrigen Basis Salvia - Base baja verte



Cod. 518B0001
BASE BASSA BURRO h cm 7,5
Low base cream - Base basse crème
Niedrigen Basis Burro - Base baja crema



Cod. 518C0001
BASE BASSA CAFFÈ h cm 7,5
Low base coffee - Base basse brun
Niedrigen Basis Caffè - Base baja marron



Cod. 518D0001
BASE BASSA CARBONE h cm 7,5
Low base coal - Base basse gris
Niedrigen Basis Carbone - Base baja gris

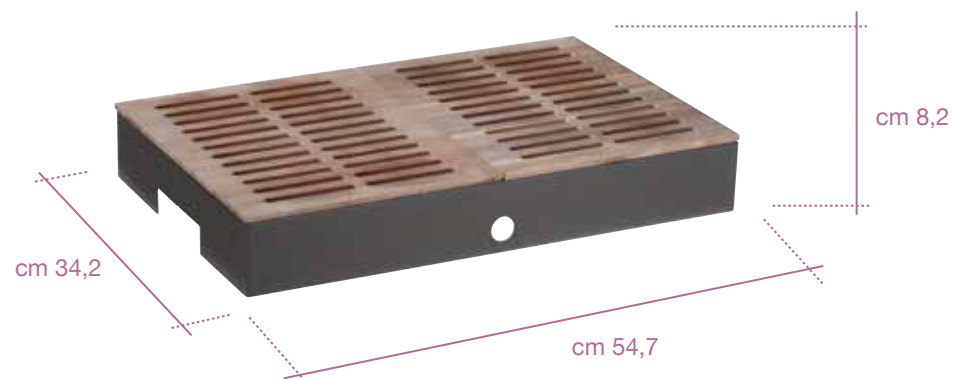

TAGLIERE PANE IN NOCE CANALETTO

"Canaletto" walnut bread chopping board.

Planche à couper le pain.

Scneidbrett.

Brotschneidebrett in Nussbaumfarbe.



PINOT
WINE & FOOD

PINOT
WINE & FOOD

LA PARTE FUNZIONALE



Cod. F1800940
VASSOIO PER FORMAGGI
Rectangular cheese tray with non-deformable polypropilene board - Plateau à fromages avec planche à découper en polypropylène - Rechteckiges Kaesetablett 1/1 aus Polypropylen mit Rolltop, hoher Widerstand - Bandeja rectangular para queso con tabla de polipropileno

COMPOSIZIONE:

Cod. 97150858
1 TAGLIERE IN POLIETILENE
NERO cm 54,7x34,2
Polyethylene board
Hachoir en polyéthylène
Küchenbrett aus Polyethylen
Tabla en polietileno

Cod. 97150856
1 CUPOLA RETT. APRIBILE PC
Rectangular dome lid
Cloche rectangulaire
Rolltop
Campana rectangular

LE BASI



Cod. 518A0001
BASE BASSA SALVIA h cm 7,5
Low base sage - Base basse vert
Niedrigen Basis Salvia - Base baja verde



Cod. 518B0001
BASE BASSA BURRO h cm 7,5
Low base cream - Base basse crème
Niedrigen Basis Burro - Base baja crema



Cod. 518C0001
BASE BASSA CAFFÈ h cm 7,5
Low base coffee - Base basse brun
Niedrigen Basis Caffè - Base baja marron



Cod. 518D0001
BASE BASSA CARBONE h cm 7,5
Low base coal - Base basse gris
Niedrigen Basis Carbone - Base baja gris



VASSOIO PER FORMAGGI CON TAGLIERE IN POLIETILENE

Rectangular cheese tray with non-deformable polyethylene board.
Plateau à fromages avec planche à découper en polyéthylène.
Rechteckiges Kaesetablett aus Polyethylen mit Rolltop, hoher Widerstand.
Bandeja rectangular para queso con tabla de polietileno.



LA PARTE FUNZIONALE



Cod.F1800920
VASSOIO PER PASTICCERIA
Rectangular tray with cover for pastries
- Plateau rectangulaire à pâtisserie -
Rechteckiges tablett 1/1 mit rolltop - Bandeja
rectangular para pastelería

COMPOSIZIONE:

Cod. 5BA11020
1 BACINELLE GN 1/1 h 20
Gastronorm bain marie basin
Bac de bain-marie GN
Wasserbad-Wanne GN
Recipiente baño-maría GN

Cod. 97150856
1 CUPOLE RETT. APRIBILE PC
Rectangular dome lid
Cloche rectangulaire
Rolltop
Campana rectangular

LE BASI



Cod. 518A0001
BASE BASSA SALVIA h cm 7,5
Low base sage - Base basse vert
Niedrigen Basis Salvia - Base baja verte



Cod. 518B0001
BASE BASSA BURRO h cm 7,5
Low base cream - Base basse crème
Niedrigen Basis Burro - Base baja crema



Cod. 518C0001
BASE BASSA CAFFÈ h cm 7,5
Low base coffee - Base basse brun
Niedrigen Basis Caffè - Base baja marron



Cod. 518D0001
BASE BASSA CARBONE h cm 7,5
Low base coal - Base basse gris
Niedrigen Basis Carbone - Base baja gris



VASSOIO PASTICCERIA

Rectangular tray with cover for pastries.

Plateau rectangulaire à pâtisserie.

Rechteckiges tablett 1/1 mit rolltop.

Bandeja rectangular para pastelería.



LA PARTE FUNZIONALE



Cod. F1803200
PORTA FRUTTA
Tray for fruit - Fruitier - Etagen-Obstschale -
Frutero

COMPOSIZIONE:

Cod. 5TIR1140
1 TEGLIA GN 1/1 h 40
C/RINGHIERE
GN tray with edges
Plat GN avec bords
Bain-marie deckel mit schlitz
Baño maria gastronomico



LE BASI



Cod. 518A0001
BASE BASSA SALVIA h cm 7,5
Low base sage - Base basse vert
Niedrigen Basis Salvia - Base baja verte



Cod. 518B0001
BASE BASSA BURRO h cm 7,5
Low base cream - Base basse crème
Niedrigen Basis Burro - Base baja crema



Cod. 518C0001
BASE BASSA CAFFÈ h cm 7,5
Low base coffee - Base basse brun
Niedrigen Basis Caffè - Base baja marron



Cod. 518D0001
BASE BASSA CARBONE h cm 7,5
Low base coal - Base basse gris
Niedrigen Basis Carbone - Base baja gris



PORTA FRUTTA

Tray for fruit.
Fruitier.
Etagen-Obstschale.
Frutero.



POSSIBILI COMBINAZIONI



BASE BASSA + ALZATA BASSA
Low base + low display bridge



BASE BASSA + ALZATA MEDIA
Low base + medium display bridge



BASE BASSA + ALZATA ALTA
Low base + high display bridge



BASE MEDIA + ALZATA MEDIA
Medium base + medium display bridge



Cod. 518A0008
ALZATA ALTA SALVIA 57,5x17x30 h cm
High display bridge sage - Plateau haute vert
Hoher Etagerer Salvia - Pisos alta verte

Cod. 518A0009
ALZATA MEDIA SALVIA 56,1x17x19,2 h cm
Medium display bridge sage - Plateau moyenne vert
Mittelgroße Etagerer Salvia - Pisos media verte

Cod. 518A0010
ALZATA BASSA SALVIA 54,7x17x8,5 h cm
Low display bridge sage - Plateau basse vert
Niedrigen Etagerer Salvia - Pisos verte



Cod. 518C0008
ALZATA ALTA CAFFÈ 57,5x17x30 h cm
High display bridge coffee - Plateau haute brun
Hoher Etagerer Caffè - Pisos alta marron

Cod. 518C0009
ALZATA MEDIA CAFFÈ 56,1x17x19,2 h cm
Medium display bridge coffee - Plateau moyenne brun
Mittelgroße Etagerer Caffè - Pisos media marron

Cod. 518C0010
ALZATA BASSA CAFFÈ 54,7x17x8,5 h cm
Low display bridge coffee - Plateau basse brun
Niedrigen Etagerer Caffè - Pisos marron



Cod. 518B0008
ALZATA ALTA BURRO 57,5x17x30 h cm
High display bridge cream - Plateau haute crème
Hoher Etagerer Burro - Pisos alta crema

Cod. 518B0009
ALZATA MEDIA BURRO 56,1x17x19,2 h cm
Medium display bridge cream - Plateau moyenne crème
Mittelgroße Etagerer Burro - Pisos media crema

Cod. 518B0010
ALZATA BASSA BURRO 54,7x17x8,5 h cm
low display bridge cream Plateau basse crème
Niedrigen Etagerer Burro - Pisos crema



Cod. 518D0008
ALZATA ALTA CARBONE 57,5x17x30 h cm
High display bridge coal - Plateau haute gris
Hoher Etagerer Carbone - Pisos alta gris

Cod. 518D0009
ALZATA MEDIA CARBONE 56,1x17x19,2 h cm
Medium display bridge coal - Plateau moyenne gris
Mittelgroße Etagerer Carbone - Pisos media gris

Cod. 518D0010
ALZATA BASSA CARBONE 54,7x17x8,5 h cm
Low display bridge coal - Plateau basse gris
Niedrigen Etagerer Carbone - Pisos gris



Pinti buffet
MADE IN ITALY

PINTI buffet

Pinti buffet

VASSOIETTO A INCASTRO IN ACCIAIO INOX

Steel interlocking tray

NEW



Cod. 5180016
VASSOIETTO A INCASTRO IN
ACCIAIO INOX GRANDE cm 30
30x8x5h cm
Big steel interlocking tray
Repose couvert accrochable grand
en acier
Große (Besteck)-ablage aus Stahl
zum Einhängen
Bandeja deslizante de acero grande



Cod. 5180015
VASSOIETTO A INCASTRO IN
ACCIAIO INOX PICCOLO cm 20
20x8x5h cm
Small steel interlocking tray
Repose couvert accrochable petit
en acier
Kleine (Besteck)-ablage aus Stahl
zum Einhängen
Bandeja deslizante de acero
pequeña

POSSIBILI ALLESTIMENTI: Possible combinations:





PINTI *buffet*

CALEIDO

-

LE BASI A PONTE

Display Bridge Base

Les Supports à Pont

Einsätze für Basis

Bandejas a Puente



Buntal
MADE IN ITALY

Buntal

BASI



Cod. 518A0004
BASE A PONTE SALVIA
55,7x34,8x37,8h cm
Display Bridge base sage - Support
à pont vert - Etagere Salvia -
Bandejas a puente verde



Cod. 518B0004
BASE A PONTE BURRO
55,7x34,8x37,8h cm
Display Bridge base cream -
Support à pont crème - Etagere
Burro - Bandejas a puente crema



Cod. 518C0004
BASE A PONTE CAFFÈ
55,7x34,8x37,8h cm
Display Bridge base coffee -
Support à pont brun - Etagere Caffè
- Bandejas a puente marron



Cod. 518D0004
BASE A PONTE CARBONE
55,7x34,8x37,8h cm
Display Bridge base coal - Support
à pont gris - Etagere Carbone -
Bandejas a puente gris

BASE A PONTE Display Bridge Base

POSSIBILI ALLESTIMENTI:

Possible combinations (with Display Bridge Base):



Cod. F1807000
CESTA PANE IN TESSUTO
Woven bread basket



Cod. F1803100
PORTA BURRO E MARMELLATA REFRIG.
Perforated and refrigerated tray with cover
for jam and butter



Cod. F1803200
PORTA frutta
Tray for fruit



Cod. F1800920
VASSOIO PASTICCERIA
Tray for pastries



Cod. F1800950
VASSOIO PER AFFETTATI REFRIGERATO
Refrigerated tray with cover for sliced salami





ALZATE 2 PIANI

Double decker displays

TUTTE LE COMBINAZIONI PER ALZATA 2 PIANI
All the items that can be used under the display bridge base
to create a double decker display



VASSOIO PER AFFETTATI REFRIG.
Refrigerated tray for sliced salami



PORTA BURRO-MARMEL. REFRIG.
Refrigerated tray for jam and butter



PORTA VERDURE 4 SCOMP. REFR.
Refrigerated basin for vegetables



TAGLIERE PANE
Bread board



VASSOIO PASTICCERIA
Tray for pastries



PORTA YOGURT REFRIG.
Refrigerated tray with holes for yoghurt



PIASTRA ACCIAIO REFRIG.
Refrigerated stainless steel plate



PORTA UOVO-VERDURE REFRIG.
Refrigerated tray for eggs and vegetables



VASSOIO FORMAGGI
Cheese tray



PORTA FRUTTA
Tray for fruit



PINTI *buffet*

CALEIDO

-

I DISTRIBUTORI

Dispensers

Les Distributeurs

Spender

Distribuidores



LA PARTE FUNZIONALE



Cod. F1805413
DISTRIBUTORE SUCCHI It 5
Juice and cold drink dispenser - Fontaine à jus de fruits simple paroi - Spender für Saft und kalte Getränke - Surtidor de zumos y bebidas con grifo Tomlinson

COMPOSIZIONE:

Cod. 97150863
1 CONTENITORE IN VETRO CON RUBINETTO It 5
Juice dispenser with tap - Fontaine à jus de fruits avec robinet - Saftspender mit shahn - Surtidor de zumos con grifo

Cod. 97150865
1 VASCHETTA PER DISTRIB. SUCCHI
Juices bowl distributor - Petit bac pour fontaine à jus - Schale für Saftspender - Cubeta de surtidor de zumos

Cod. 97150866
1 COPERCHIO PER VASCHETTA DISTR. SUCCHI
Lid for juices bowl distributor - Couvercle petit bac pour fontaine à jus - Deckel für Saftspender - Tapa por cubeta de surtidor de zumos

Cod. 97150867
1 GEL PACK cm 15x14
Refrigerating brick - Briquette réfrigérante - Kühlakku - Refrigerad

Cod. 5BA16020
1 BACINELLA GN 1/6 h 20
Gastronorm basin - Bac gastronorm - Durchbrochener basis - Cubeta gastronómico

Cod. 50902613
1 GRIGLIA 1/6 PER DISTRIBUTORE
Grill for dispenser - Grille pour distributeur - Rost für Getränkedispenser - Baño maria gastronómico

LE BASI



Cod. 518A0006
BASE DISTRIB. SUCCHI SALVIA h cm 24
Structure for juice dispenser sage - Structure pour distributeur à jus vert - Struktur für Saftdispenser Salvia - Estructura para dispensador de zumos verde



Cod. 518B0006
BASE DISTRIB. SUCCHI BURRO h cm 24
Structure for juice dispenser cream - Structure pour distributeur à jus crème - Struktur für Saftdispenser Burro - Estructura para dispensador de zumos crema



Cod. 518C0006
BASE DISTRIB. SUCCHI CAFFÈ h cm 24
Structure for juice dispenser coffee - Structure pour distributeur à jus brun - Struktur für Saftdispenser Caffè - Estructura para dispensador de zumos marron



Cod. 518D0006
BASE DISTR. SUCCHI CARBONE h cm 24
Structure for juice dispenser coal - Structure pour distributeur à jus gris - Struktur für Saftdispenser Carbone - Estructura para dispensador de zumos gris



SET 4 ANGOLARI PER DISTRIBUTORE SUCCHI
Set 4 pcs corner covering for juice dispenser.
Set de 4 couvre-coins pour base distributeur à jus.
Eckabdeckung 4tlg. für Saftspender.
Set de 4 cubre esquina para el surtidor de zumos y bebidas.



DISTRIBUTORE SUCCHI It 5

Juice and cold drink dispenser.

Fontaine à jus de fruits simple paroi.

Spender für Saft und kalte Getränke.

Surtidor de zumos y bebidas con grifo Tomlinson.



LA PARTE FUNZIONALE



Cod. F1805420
DISTRIBUTORE SUCCHI It 7
Juice and cold drink dispenser - Fontaine à jus de fruits simple paroi - Spender für Saft und kalte Getränke - Surtidor de zumos y bebidas con grifo Tomlinson

COMPOSIZIONE:

Cod. 97150864
1 CONTENITORE IN VETRO CON RUBINETTO It 7
Juice dispenser with tap - Fontaine à jus de fruits avec robinet - Saftspender mit shahn - Surtidor de zumos con grifo

Cod. 97150865
1 VASCHETTA PER DISTRIB. SUCCHI
Juices bowl distributor - Petit bac pour fontaine à jus - Schale für Saftspender - Cubeta de surtidor de zumos

Cod. 97150866
1 COPERCHIO PER VASCHETTA DISTR. SUCCHI
Lid for juices bowl distributor - Couvercle petit bac pour fontaine à jus - Deckel für Saftspender - Tapa por cubeta de surtidor de zumos

Cod. 97150867
1 GEL PACK cm 15x14
Refrigerating brick - Briquette réfrigérante - Kühlakku - Refrigerad

Cod. 5BA16020
1 BACINELLA GN 1/6 h 20
Gastronorm basin - Bac gastronorm - Durchbrochener basis - Cubeta gastronómico

Cod. 50902613
1 GRIGLIA 1/6 PER DISTRIBUTORE
Grill for dispenser - Grille pour distributeur - Rost für Getränkedispenser - Baño maria gastronómico

LE BASI



Cod. 518A0006
BASE DISTRIBUT. SUCCHI SALVIA h cm 24
Structure for juice dispenser sage - Structure pour distributeur à jus vert - Struktur für Saftdispenser Salvia - Estructura para dispensador de zumos verde



Cod. 518B0006
BASE DISTRIBUT. SUCCHI BURRO h cm 24
Structure for juice dispenser cream - Structure pour distributeur à jus crème - Struktur für Saftdispenser Burro - Estructura para dispensador de zumos crema



Cod. 518C0006
BASE DISTRIBUT. SUCCHI CAFFÈ h cm 24
Structure for juice dispenser coffee - Structure pour distributeur à jus brun - Struktur für Saftdispenser Caffè - Estructura para dispensador de zumos marron



Cod. 518D0006
BASE DISTR. SUCCHI CARBONE h cm 24
Structure for juice dispenser coal - Structure pour distributeur à jus gris - Struktur für Saftdispenser Carbone - Estructura para dispensador de zumos gris



SET 4 ANGOLARI PER DISTRIBUTORE SUCCHI

Set 4 pcs corner covering for juice dispenser.
Set de 4 couvre-coins pour base distributeur à jus.
Eckabdeckung 4tlg. für Saftspender.
Set de 4 cubre esquina para el surtidor de zumos y bebidas.



DISTRIBUTORE SUCCHI It 7

Juice and cold drink dispenser.

Fontaine à jus de fruits simple paroi.

Spender für Saft und kalte Getränke.

Surtidor de zumos y bebidas con grifo Tomlinson.



LA PARTE FUNZIONALE



Cod. F1809527
DISTRIBUTORE BEVANDE CALDE It 5
SATIN FINISH
Hot drinks dispenser provided with electric resistance - Distributeurs de boissons chaudes avec résistance électrique - Spender für warme Getränke ausgestattet mit elektrischer Heizung - Distribuidores de bebidas calientes con resistencia eléctrica

COMPOSIZIONE:

Cod. F0959516
1 DISTRIB. BEVANDE CALDE C/MANIGLIE It 5
Hot drink dispenser - Distributeur de boissons chaudes - Spender für warme Getränke - Rejilla para dispensador

Cod. 5BA16020
1 BACINELLA GN 1/6 h 20
Gastronom basin - Bac gastronom - Durchbrochener basis - Cubeta gastronómico

Cod. 50902613
1 GRIGLIA 1/6 PER DISTRIBUTORE
Grill for dispenser. - Grille pour distributeur - Rost für Getränkedispenser - Baño maria gastronómico

Cod. F1803116
1 COPERCHIO PER DISTR. BEVANDE CALDE
Lid for dispenser - Couvercle pour distributeur - Deckel für dispenser - Tapa para dispensador

Cod. 97150221
1 RUBINETTO SMONT. IN PPL TOMLINSON
Tomlinson PPL faucet - Robinet démontable en PPL Tomlinson - Abnehmbarer hahn aus PPL Tomlinson - Grifo desmontable de PPL Tomlinson

Cod. 97150870
1 RESISTENZA ELETTRICA
140 W
Electric resistance - Résistance électrique - Elektrischer Widerstand - Resistencia eléctrica

LE BASI



Cod. 518A0007
BASE DISTRIB. BEVANDE CALDE SALVIA
Structure for hot drink dispenser sage - Struct. pour distrib. à boissons chaudes vert - Struktur für warme Getränke Dispenser Salvia - Estructura para disp. de bebidas calientes verde



Cod. 518B0007
BASE DISTRIB. BEVANDE CALDE BURRO
Structure for hot drink dispenser cream - Struct. pour distrib. à boissons chaudes crème - Struktur für warme Getränke Dispenser Burro - Estructura para disp. de bebidas calientes crema



Cod. 518C0007
BASE DISTRIB. BEVANDE CALDE CAFFÈ
Structure for hot drink dispenser coffee - Struct. pour distrib. à boissons chaudes brun - Struktur für warme Getränke Dispenser Caffè - Estructura para disp. de bebidas calientes marron



Cod. 518D0007
BASE DISTR. BEVANDE CALDE CARBONE
Structure for hot drink dispenser coal - Struct. pour distrib. à boissons chaudes gris - Struktur für warme Getränke Dispenser Carbone - Estructura para disp. de bebidas calientes gris



DISTRIBUTORE BEVANDE CALDE CON RESISTENZA ELETTRICA It 5 - SATIN FINISH

Hot drinks dispenser provided with electric resistance.
Distributeurs de boissons chaudes avec résistance électrique.
Spender für warme Getränke ausgestattet mit elektrischer Heizung.
Distribuidores de bebidas calientes con resistencia eléctrica.



COMPOSIZIONE

1 PORTA BROCCHE h cm 7,5
 Jug holder
 Porte-carafes
 Krughalter
 Porta-jarras
 Cod. 518A0005 SALVIA / sage
 Cod. 518B0005 BURRO / cream
 Cod. 518C0005 CAFFÈ / coffee
 Cod. 518D0005 CARBONE / coal

Cod. 97150305
 1 VASCHETTA RACCOGLI GOCCE
 Drop-saver bowl
 Bac à goutess
 Tropfschale
 Cubeta de recoger gotas

Cod. 97150276
 2 GEL PACK cm 20x9,8
 Refrigerating brick
 Briquette réfrigérante
 Kühlakku
 Refrigirad

Cod. 97150861
 1 COPERCHIO INOX PER
 VASCHETTA RACCOGLI GOCCE
 Drop-saver lid for drop-saver bowl
 Couvercle por bac à goutes
 Edelstahlabdeckung für Tropfschale
 Tapa de acero por cubeta de recoger gotas

Cod. 9715N874
 3 CARAFFA CON
 COPERCHIO It 2,2
 Jug with lid
 Carafe avec couvercle
 Karaffe mit Deckel
 Jarra con tapa



Cod. 518A9618
 DISTRIBUTORE CEREALI / SUCCHI SALVIA
 39x12,8x30 h cm
 Cereal dispenser / Juice dispenser sage.
 Distributeur à céréales / Fontaine à jus de fruits vert.
 Cerealien-Spender / Spender für Saft Salvia.
 Dispensador de cereales / Surtidor de zumos verde.



Cod. 518B9618
 DISTRIBUTORE CEREALI / SUCCHI BURRO
 39x12,8x30 h cm
 Cereal dispenser / Juice dispense cream.
 Distributeur à céréales / Fontaine à jus de fruits crème.
 Cerealien-Spender / Spender für Saf Burro.
 Dispensador de cereales / Surtidor de zumos crema.



Cod. 518C9618
 DISTRIBUTORE CEREALI / SUCCHI CAFFÈ
 39x12,8x30 h cm
 Cereal dispenser / Juice dispense coffee.
 Distributeur à céréales / Fontaine à jus de fruitss brun.
 Cerealien-Spender / Spender für Saf Caffè.
 Dispensador de cereales / Surtidor de zumos marron.



Cod. 518D9618
 DISTRIBUTORE CEREALI / SUCCHI CARBONE
 39x12,8x30 h cm
 Cereal dispenser / Juice dispense coal.
 Distributeur à céréales / Fontaine à jus de fruits gris.
 Cerealien-Spender / Spender für Saf Carbone.
 Dispensador de cereales / Surtidor de zumos gris.



PINTI *buffet*

CALEIDO

-

Avete in mente un colore particolare?

Possiamo realizzare le basi proprio con quel colore! Per prezzi, tempistiche e ordini minimi contattateci.

Are you thinking about a particular colour?

We can make bases using it! Contact us for prices, lead time and MOQ.



RICAMBI

Spare parts

Cod. 97150856 CUPOLA RETTANGOLARE / Rectangular dome lid

Cod. 97150857 PIASTRA INOX / Refrigerated stainless steel plate

Cod. 97150858 TAGLIERE IN POLIETILENE cm 54,7x34,2 / Polyethylene board cm 54,7x34,2

Cod. 97150859 TAGLIERE PANE IN NOCE CANALETTO cm 27,5x34,5 / Bread board cm 27,5x34,5

Cod. 97150860 CESTA PANE IN TESSUTO / Woven bread basket

Cod. F1800014 RIALZO INTERNO PER PIASTRA INOX SMALL / Internal metal support for small stainless steel plate

Cod. 97150861 COPERCHIO VASCHETTA RACCOGLI GOCCE / Drop-saver lid for drop-saver bowl

Cod. 97150305 VASCHETTA RACCOGLI GOCCE / Drop-saver bowl

Cod. 9715N874 CARAFFA IN BOROSILICATO CON COPERCHIO /Jug with lid

Cod. 97150863 CONTENITORE IN VETRO CON RUBINETTO LT 5 / Juice glass dispenser with tap lt 5

Cod. 97150864 CONTENITORE IN VETRO CON RUBINETTO LT 7 / Juice glass dispenser with tap lt 7

Cod. 97150865 VASCHETTA PER DISTRIBUTORE SUCCHI / Juices bowl distributor

Cod. 518_0013 SET 4 ANGOLARI PER DISTRIBUTORE SUCCHI (A Salvia; B Burro; C Caffè; D Carbone) / Set 4 pcs corner covering for juice dispenser (A Sage; B Cream; C Coffee; D Coal)

Cod. 97150866 COPERCHIO PER VASCHETTA DISTRIBUTORE SUCCHI / Lid for juices bowl distributor

Cod. 97150867 GEL PACK cm 15x14 / Refrigerating brick cm 15x14

Cod. 97150276 GEL PACK cm 20x9,8 / Refrigerating brick cm 20x9,8

Cod. F0959516 DISTRIBUTORE BEVANDE CALDE C/MANIGLIE lt 5 / Hot drink dispenser lt 5

Cod. F1803116 COPERCHIO PER DISTRIBUTORE BEVANDE CALDE / Lid for hot drink dispenser

Cod. 97150221 RUBINETTO COMPLETO TOMLINSON / Tomlinson faucet

Cod. 97150868 CESTA PANE RETTANGOLARE WENGE C/FORCELLA CON CUPOLA cm 52,5x32x29,5 / Wenge rectangular bread basket with hooks with cover cm 52,5x32x29,5

Cod. 97150869 CESTA PANE RETTANGOLARE PAGLIA C/FORCELLA CON CUPOLA cm 52,5x32x12 / Paill rectangular bread basket with hooks with cover cm 52,5x32x12

Cod. 97150870 RESISTENZA PER DISTRIBUTORE BEVANDE CALDE 140 W / Heater for hot drink dispenser 140 W

Cod. 97150118 RESISTENZA CON REGOLATORE PER CHAFING DISH 230 V 700 W / Heater with adjuster for chafing dish 230 V 700 W

Cod. 97200078 FORNELLETTO INOX / Stainless steel burner holder

Cod. 97150071 SUPPORTO PER FRIZIONE CHAFING DISH / Friction support for chafing dish

Cod. 97150023 FRIZIONE DESTRA CHAFING DISH / Friction right for chafing dish

Cod. 97150024 FRIZIONE SINISTRA CHAFING DISH / Friction left for chafing dish

Cod.90230815 TARGHETTA "LATTE - CAFFÈ" PER BROCCA Ø cm 6,5 / Plate "Milk - Coffee" for jug Ø cm 6,5

Cod.90230810 TARGHETTA "LATTE - ACQUA CALDA" PER BROCCA Ø cm 6,5 / Plate "Milk - Hot Water" for jug Ø cm 6,5

Cod.97150570 MAZZETTA COLORI CALEIDO / Caleido colours swatch book

GASTRONORM

1/1 2/3 1/2 2/4 1/3 1/4 2/8 1/6 1/9

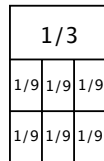
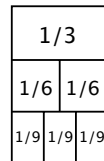
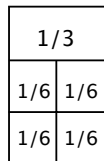
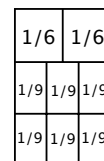
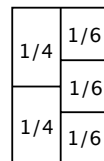
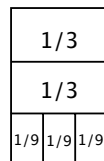
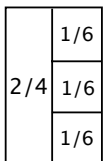
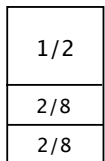
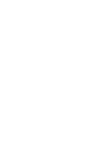
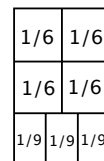
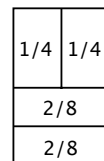
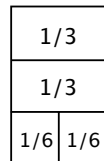
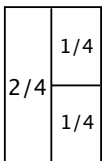
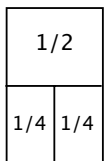
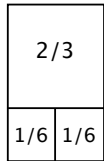

ACCIAIO E SPESSORI

La serie Gastronorm è prodotta con acciaio AISI 304, chiamato anche 18/10, negli spessori:

- 1 mm per i modelli 2/1
- 0,7 e 0,8 per le altre pezzature restanti

LUCIDATURA

Le altezze 100, 150, 200 sono sottoposte ad una operazione di normalizzazione termica e poi lucidate mediante burattatura. Oggetti di grandi dimensioni sono puliti per via elettrolitica. Le altezze 65, 40 e 20 e sottoposte a trattamento chimico che permette di ottenere una lucidatura omogenea su tutta la superficie.

CONFEZIONE

Ogni singolo pezzo è sottoposto a lavaggio speculare ad alta temperatura 90° e confezionato in polipropilene pronto per l'uso già sterilizzato.

CAPACITÀ

I raggi ridotti al min. offrono il max della capienza nel minimo ingombro.

MATERIALI

Sono tutti certificati ed idonei al contatto con gli alimenti ai sensi dell' DM. 25-1-1992 art. 4-5° comma D.L. 208 e DIR. CEE 89/109.

LAVAGGIO

Resistenti all'uso prolungato in lavastoviglie.

MISURE

In accordo con gli standard internazionali della CEE doc. CEN/TC 194 EN631-1.

THE STEEL AND THE THICKNESSES

The Gastronorm range is made of AISI 304 steel also called 18/10, in the following thicknesses:

- 1 mm for the 2/1 models
- 0,7 and 0,8 for the remaining sizes

POLISHING

Heights 100, 150 and 200 are thermally normalised and then polished by tumbling. Large items are etch cleaned. Heights 65, 40 and 20 and are subjected to a chemical treatment permitting the attainment of even polishing over the entire surface.

PACKAGING

Each individual piece is bright washed at the high temperature of 90° and packaged in polypropylene, ready for use already sterilised.

CAPACITY

The finely rounded bottom edges offer maximum capacity in the minimum space.

MATERIALS

All the materials are certified to be suitable for contact with foodstuffs according to DM. 25-1-1992 art. 4 - 5th para. D.L. 208 and EEC Directive 89/109.

WASHING

Resistant to prolonged dish-washing.

SIZES

In accordance with the international EEC standards doc. CEN/TC 194 EN631-1.

NOTE INFORMATIVE Technical information

ACCIAIO INOX 18/10

L'acciaio Inox 18/10 - Aisi 304 viene fornito esclusivamente dalle principali acciaierie europee. La sua eccezionale resistenza alla ruggine, la brillantezza e le caratteristiche igieniche soddisfano i requisiti della moderna gastronomia. Esso infatti resiste agli acidi contenuti nei prodotti alimentari, nei detersivi. L'acciaio Inox 18/10 è antiurto e particolarmente adatto al lavaggio in lavastoviglie.

POLICARBONATO (PC)

Il policarbonato è un polimero di pregio che racchiude alcune caratteristiche della plastica, dell'acciaio e del vetro. La trasparenza si avvicina al 90%. La resistenza meccanica alla deformazione ha un'elevata resistenza all'urto. L'elevata stabilità dimensionale viene garantita fino ad una temperatura di 130 gradi. In presenza di fiamma è autoestinguente.

Avvertenze. Non resiste a: soluzioni alcaline, acetone, ammoniacca, benzolo ed alcool metilico. Il materiale è sicuro dal punto di vista fisiologico e può andare a contatto con gli alimenti.

COMPONENTI IN LEGNO

Tutti i prodotti in legno sono realizzati in noce canaletto.

Avvertenze. Per mantenere a lungo la qualità del prodotto è necessario:

- Non immergere in liquidi o acqua
- Pulire con panno umido d'acqua
- Asciugare sempre con cura
- Evitare l'utilizzo di sostanze abrasive
- Tenere lontano da fiamme libere o fonti di calore
- Evitare l'esposizione prolungata al sole, per evitare variazione di colore e deformazioni.

NB. Il legno essendo un prodotto naturale può assumere tolleranze diverse a seconda della temperatura e dell'umidità presente nell'ambiente circostante. Sono possibili eventuali gradazioni di colore e venature in quanto prodotto in legno naturale.

POLIETILENE

Il polietilene è ad alta resistenza e garantito per alimenti.

RESISTENZE

Sono adatte a un voltaggio di 220 Volts e dotate di spina schuko. Conformi alle leggi CEE. Per distributore bevande calde o chafing dish non utilizzare con contenitori vuoti. Per il corretto utilizzo e per la manutenzione fare comunque riferimento alle note presenti all'interno della confezione.

18/10 AISI 304 STAINLESS STEEL

18/10 AISI 304 stainless steel is supplied almost exclusively by the main European steelworks. Its exceptional rust resistance, its brilliance and hygienic qualities satisfy the requirements of modern gastronomy; in fact, it resists to the acids contained in foodstuffs, detergents and is shockproof. 18/10 steel is dishwasher safe.

POLYCARBONATE (PC)

Polycarbonate is a valuable polymer that has some characteristics from plastics, steel and glass. Its transparency is close to 90%. Its strain strength has a high impact strength. Its high dimensional stability is guaranteed up to a 130-degree temperature. In the presence of flame, it is self-extinguishing.

Warning: it does not withstand: alkaline solutions, acetone, ammonia, benzol and methyl alcohol. The material is safe from the physiological point of view and can get in touch with food.

WOOD COMPONENTS

All the wood products are made in Canaletto walnut.

Warning. To guarantee the quality of the product in the time:

- Do not plunge in liquids or in water
- Clean with a water-dampened cloth
- Dry with care
- Do not use abrasive agents or solvents
- Keep away from flames or heat sources
- Do not expose to the sun for a long-time to avoid colour changes and deformations.

N.B.Wood is a natural product and can have different tolerances according to the environment temperature and humidity.

This product made of natural wood may have different colour nuances and veins China is suitable for food usage and does not contain harmful substances or release dangerous elements.

POLYETHYLENE

Polyethylene is highly resistant and suitable for foodstuff.

RESISTANCES

The electric resistance is suitable for 220 W voltage and are provided with schuko plug . In compliance with CEE norm. For hot drink dispenser and chafing dish. Do not use with empty drink dispenser and chafing dish. For a correct use please refer to the instructions leaflet inside the box.

PINTI *buffet*

CALEIDO

-

PINTI INOX S.p.A.
Via Antonini, 87
25068 Sarezzo (BS) Italia
Tel. +39 030 89351
Fax +39 030 8935250
+39 030 8901163
pintinox@pinti.it
www.pintinox.com

PINTI INOX GMBH DEUTSCHLAND
Römerstraße 91
73066 Uhingen
Tel +49 07161 93343-0
Fax +49 07161 352789
info@pinti.de
www.pinti.de

-

Si ringrazia il ristorante *Nineteen - 19* a Brescia per l'ospitalità nelle foto ambientate.

art director: Daniele Ardisson
product manager: Ruggero Borghetti
graphic design: Elena Maccabiani
photos: Claudio Sambinelli